



HUNG TA INSTRUMENT CO., LTD.

Computer Universal Testing Machines



Advanced Testing Systems
helping engineers worldwide develop safer,
more reliable materials and components.



HT-2402 Series Computer Servo Control Material Testing Machines

Computer Universal Testing Machines – Main Body & Control System

- **High Precision, High Accuracy, High Stability** Material Testing Machines – able to do tensile, compression, flexural and bending test.
- ISO 9001 and CE certified, superior products fabricated by highly trained and experienced personnel.



• High Strength Structure

High strength aluminum alloy combined with streamlined design, elegant, bright and generous.

• High Stability

Using Ball screw, less loss of kinetic energy and eliminating noise.

• High Precision Load Cell

Features a low-profile load cell, with stable load induction, high accuracy, high stability, and a safety factor of 150 %.

• Computer System

Outstanding software , powerful control functions.

• Easy Operation

Superior function with quick operation, and testing speed range is from 0.005 ~ 500 or 1000 mm/min.

• Standardization

A range of testing grips specification standardized modular replacement design, switch grips easily and fast for different testing samples.

Cap.: 1 ~ 50 kN

Machine Base
(Optional)

HT-2402 Series

HT-2402 Series (1 ~ 20 kN)

* S = Standard * SH = Special Height * SW = Special Width * SHW = Special Height & Width

Type	HT-2402 S05	HT-2402 SH05	HT-2402 SW05	HT-2402 SHW05	HT-2402 S1	HT-2402 SH1	HT-2402 SW1	HT-2402 SHW1	HT-2402 S2	HT-2402 SH2
Capacity Selection (kN)	1, 2, 5				10				20	
Force Resolution	1/200,000 (HUNG TA Interface card)									
The Force Relative Error	Class 0.5 $\leq \pm 0.5\%$ or Class 1 $\leq \pm 1\%$									
Testing Speed Range (mm/min)	0.005 ~ 1000 mm / min					0.005 ~ 500 mm / min				
Crosshead Speed Relative Error	Class 0.5 $\leq \pm 0.5\%$ or Class 1 $\leq \pm 1\%$									
Effective Testing Width (mm)	420		860		420		860		420	
Crosshead Working Table Distance (mm)	1270	1770	1305	1805	1270	1770	1305	1805	1305	1805
Power Supply	AC Servo Motor & Servo Driver									
Power	1-Phase 220V, 0.6 kVA									
Machine Dimension (W x D x H) (cm)	80 x 66 x 174.5	80 x 66 x 224.5	124 x 67.5 x 174	124 x 67.5 x 224	80 x 67.5 x 174	80 x 67.5 x 224	124 x 67.5 x 174	124 x 67.5 x 224	80 x 67.5 x 174	80 x 66 x 224.5
Machine Weight (Without Machine Stand) (kg)	130	150	150	180	130	150	150	180	160	180
Standard Accessories	Tool Kit x 1 Set, Operation Manual x 1 Set, Warranty Paper x 1 Set, TAF Certificate Report x 1 Set									
Optional Accessories	Extensometer	Refer to the specifications of HT-8160, HT-9160, HT-9161 (Optional)								
	Thermostat Chamber	Refer to the specifications of HT-8747 (Optional)								
	Grip	Refer to the brochure of grips and fixtures, or provide specifications or actual samples for design and manufacture (Optional)								
	Machine Stand	HT-2402 Machine Stand (Optional, around 40kg)								

HT-2402 Series (10 ~ 50 kN)

* S = Standard * SH = Special Height * SW = Special Width * SHW = Special Height & Width

Type	HT-2402SW2	HT-2402SHW2	HT-2402S5	HT-2402SH5	HT-2402SW5	HT-2402SHW5
Capacity Selection (kN)	20			50		
Force Resolution	1/200,000 (HUNG TA Interface card)					
The Force Relative Error	Class 0.5 $\leq \pm 0.5\%$ or Class 1 $\leq \pm 1\%$					
Testing Speed Range (mm/min)	0.005 ~ 500 mm / min					
Crosshead Speed Relative Error	Class 0.5 $\leq \pm 0.5\%$ or Class 1 $\leq \pm 1\%$					
Effective Testing Width (mm)	860		420		860	
Crosshead Working Table Distance (mm)	1305	1805	1305	1805	1305	1805
Power Supply	AC Servo Motor & Servo Driver					
Power	1-Phase 220V, 1.2 kVA			3-Phase 220V, 1.6 kVA (380V / 415V Optional)		
Machine Dimension (W x D x H) (cm)	124 x 67.5 x 174	124 x 67.5 x 224	80 x 67.5 x 174	80 x 67.5 x 224	124 x 67.5 x 174	124 x 67.5 x 224
Machine Weight (Without Machine Stand) (kg)	180	200	160	180	180	200
Standard Accessories	Tool Kit x 1 Set, Operation Manual x 1 Set, Warranty Paper x 1 Set, TAF Certificate Report x 1 Set					
Optional Accessories	Extensometer	Refer to the specifications of HT-8160, HT-9160, HT-9161 (Optional)				
	Thermostat Chamber	Refer to the specifications of HT-8747 (Optional)				
	Grip	Refer to the brochure of grips and fixtures, or provide specifications or actual samples for design and manufacture (Optional)				
	Machine Stand	HT-2402 Machine Stand (High : 68 cm, Weight : 40kg, Optional)				

HT-2402 Series Computer Universal Testing Machines (Floor Standing)

HUNG TA Testing Machines:

The accuracy and precision conforms to the requirement for international standards.

Accuracy Certifications

ASTM E4 GB / T 7314-2005

ASTM E8-04 GB / T 16826-2008

BS 1610 ISO 7500 -1:2004

CNS 9471 / 9470 ISO 6892-1:2009

EN10002-1 JIS B 7721-2002

GB / T 228-2010 JIS Z 22410-2008

GB / T 232-2010 JJG 139-1999

GB / T 17200-1997 JB/T 6146-2007

GB / T 16491-2008 JB/T 7797-1995



HT-2402

Computer Servo Control
Material Testing Machines
Cap.: 50 ~ 250 kN

HT-2402W25



HT-2402W10

HT-2402

Computer Servo Control
Material Testing Machines
Cap.: 50 ~ 250 kN

HT-2328

Computer Type Single Column
Universal Materials Testing Machines
Cap.: 0.2 ~ 2 kN



HT-2402 Series (50 ~ 250 kN)

* ST = Standard * STH = Special Height * STW = Special Width * STHW = Special Height & Width

Type	HT-2402 ST5	HT-2402 STH5	HT-2402 STW5	HT-2402 STHW5	HT-2402 ST10	HT-2402 STH10	HT-2402 STW10	HT-2402 STHW10	HT-2402 ST25	HT-2402 STH25	HT-2402 STW25	HT-2402 STHW25
Capacity Selection (kN)	50				100				250			
Force Resolution	1/200,000 (HUNG TA Interface card)											
The Force Relative Error	Class 0.5 $\leq \pm 0.5\%$ or Class 1 $\leq \pm 1\%$											
Testing Speed Range (mm/min)	0.005 ~ 500 mm / min								0.05 ~ 200 mm / min			
Crosshead Speed Relative Error	Class 0.5 $\leq \pm 0.5\%$ or Class 1 $\leq \pm 1\%$											
Effective Testing Width (mm)	560		800		560		800		560		800	
Crosshead Working Table Distance (mm)	1230	1730	1230	1730	1230	1730	1230	1730	1430	1930	1430	1930
Power Supply	AC Servo Motor & Servo Driver											
Power	3-Phase 220V, 2.5 kVA (380V / 415V Option)								3-Phase 220V, 5.7 kVA (380V / 415V Option)			
Machine Dimension (W x D x H) (cm)	110 x 76 x 215.5	110 x 76 x 265.5	136 x 76 x 215.5	136 x 76 x 265.5	110 x 76 x 215.5	110 x 76 x 265.5	136 x 76 x 215.5	136 x 76 x 265.5	117 x 86 x 245.5	117 x 86 x 295.5	141.6 x 86 x 245.5	141.6 x 86 x 295.5
Machine Weight (kg)	700	800	800	1000	700	800	800	1000	1350	1450	1450	1650
Standard Accessories	Tool Kit x 1 Set, Operation Manual x 1 Set, Warranty Paper x 1 Set, TAF Certificate Report x 1 set											
Optional Accessories	Extensometer	Refer to the specifications of HT-8160, HT-9160, HT-9161 (Optional)										
	Thermostat Chamber	Refer to the specifications of HT-8747 (Optional)										
	Grip	Refer to the brochure of grips and fixtures, or provide specifications or actual samples for design and manufacture (Optional)										

HT-2328 Series

Computer Type Single Column Universal Materials Testing Machines

HT-2328 Series (0.2 ~ 2 kN)

- Servo Motor Type, Max. Speed is 1000 mm/min
- Single Column Design, Easy Operation & Convenience

Type	HT-2328			
Capacity Selection (N)	200 N	500 N	1 kN	2 kN
Force Resolution	0.02 N	0.05 N	0.1 N	0.2 N
The Force Relative Error	Class 0.5 $\leq \pm 0.5\%$ or Class 1 $\leq \pm 1\%$			
Testing Speed Range (mm/min)	A : Servo Motor Type: 0.005 ~ 1000 mm/min, Crosshead Speed Relative Error : Class 0.5 $\leq \pm 0.5\%$ or Class 1 $\leq \pm 1\%$			
Crosshead Working Table Distance (mm)	735 mm			
Over Stroke & Overload Protection Device	Upper and lower limits protection device, when it over 10% of testing set up, the system will stop automatically for safety protection			
Power	Servo Motor : 1-Phase, 220V AC, 50/60 Hz			
Power Consumption	0.4 kVA			
Machine Dimension (W x D x H) (cm)	56 x 50 x 126.5			
Machine Weight (kg)	60			

Computer System - Super Powerful Program, With Superior Control Functions

Computer Measuring System – Control & Edit Setting Functions

Intelligently computer control & measuring software to improve testing efficiency.

Powerful Control Functions

- Basic control mode contains fixed velocity, fixed displacement, constant load speed, fixed load, constant stress speed & constant strain speed.
- Available to freely set up cyclic mode, define cyclictimes, conduct the next stage of control mode after the preset cycle is up to next set up control mode.
- Set up for tensile and compression mode.
- Control mode database management, available to repeat editing and setting.
- Control mode can cover most international test standards like GB, CNS, ASTM, ISO, DIN & JIS.
- Able to do low frequency testing.

Intelligently Computer System

- Operation system is Windows XP 32 bit or above in Chinese or English version, more safety and stability.
- The icon fined interface for easy learning operation.
- Use database management for testing standards such as sample information, testing results and expansion powerful.
- Real-time graphic switching display, catch test dynamic and high integrity. Graphics includes Load-Displacement, Load-Time, Displacement-Time, Strain-Stress, Load-Horizontal Extensometer and Load-Vertical Extensometer.
- Open editing formula, formula is easy to learn and including general test such as Metal, Rubber, Footwear, Peeling industries.
- Testing standard is able to set load point, displacement point, interval setting and yield point interval setting.
- Able to recalculate and analysis testing information or each parameter and formula change calculation.

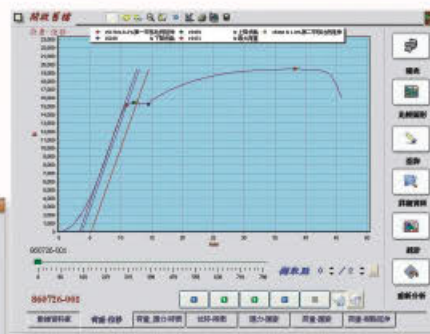
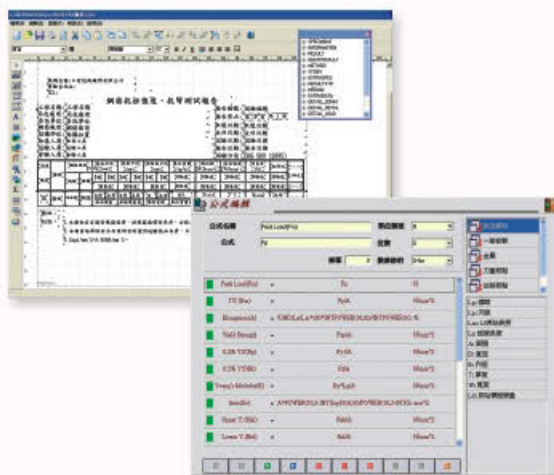
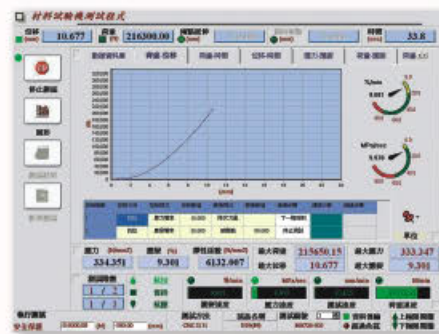
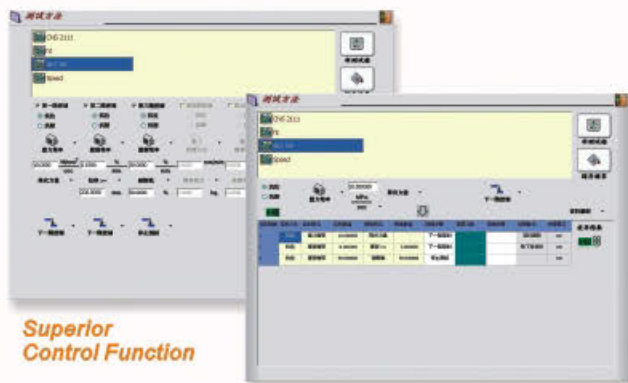

Computer System

Powerful Control Functions

L. = Loading, D. = Displacement, Ss. = Stress, Sn. = Strain

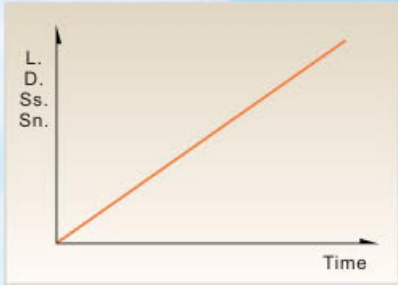

No. 01

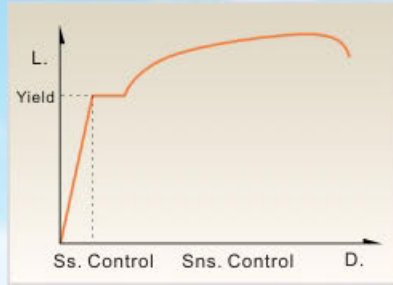

No. 02

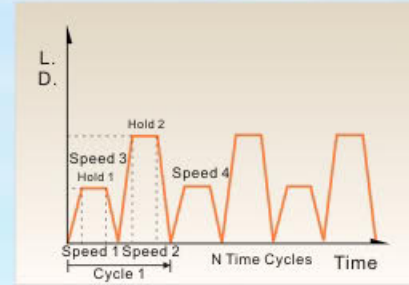

No. 03

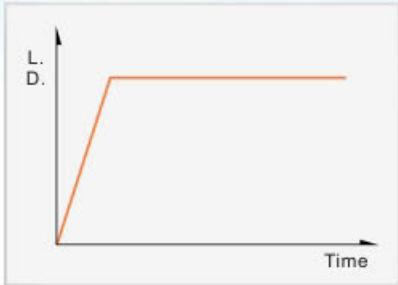

No. 04

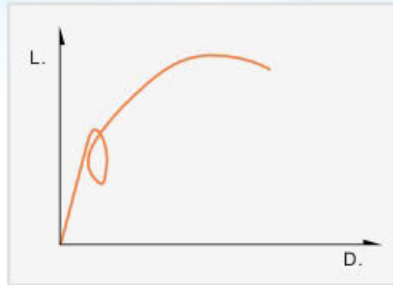

No. 05

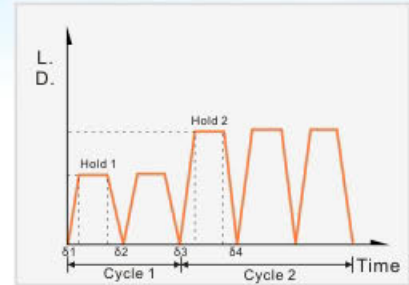

No. 06

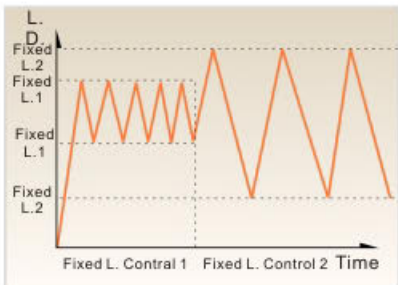

No. 07

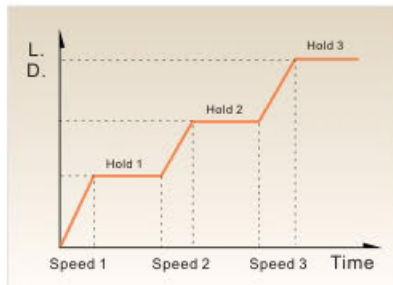

No. 08

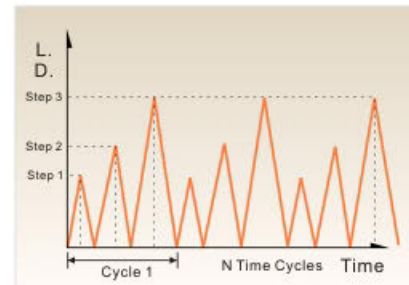

No. 09

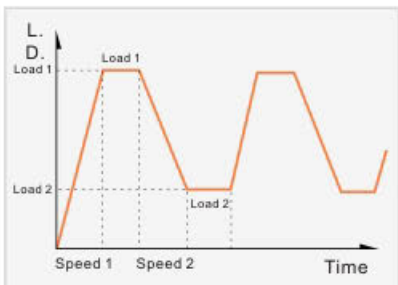

No. 10

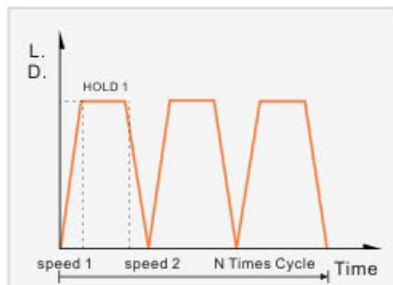

No. 11

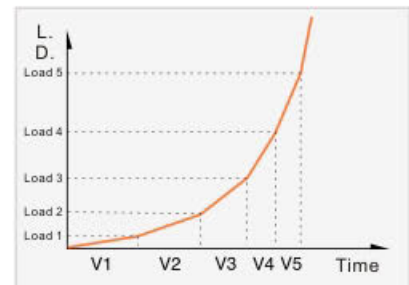

No. 12

CONTROL FUNCTION : BLOCK DIAGRAM

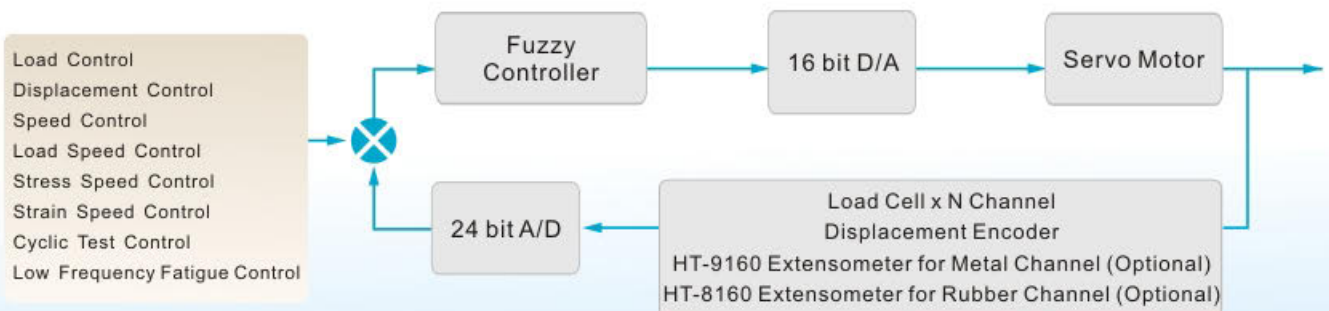

HT-8747 Series

Thermal Testing Chamber Series (Optional)



A / B / C Type High and Low Temperature Chamber (HT-8747)
Suitable for HT-2402 series tensile tester



HT-8747 D, E Type High Temperature Chamber

Model No.	HT-8747A	HT-8747B	HT-8747C	HT-8747D	HT-8747E
Temperature Range	Rt ~ + 200°C	-30 ~ + 200°C	-50 ~ + 200°C	+30 ~ + 800°C	Rt ~ + 1100°C
Inside Dimension (W x D x H)	20 x 30 x 60 cm			Ø8 x 30 cm	Ø8 x 30 cm
Outside Dimension (W x D x H)	40 x 82 x 82 cm	40 x 100 x 90 cm	40 x 120 x 90 cm	Ø35 x 40 cm	Ø35 x 40 cm
Method of Heat-up or Cool-down	Heat Type	Heat Type/Cooling Type		Heat Type	
Temperature Control	PID automatic temperature controller with digital temperature indicator				
Applied Models	Suitable for HT-2402 series tensile tester				
Power	1-Phase 220V				

HT-8160 / HT-9160 HT-9161

Series

Extensometer
Series



HT-8160 series Extensometer can be bought with HT-8747 Thermostat Testing Chamber at the same time, but unable to use both together.



HT-9161 series Made in USA

Extensometer Series

Suitable for model HT-2402 series, HT-2101, HT-9501, HT-2328 series tensile tester

Type	HT-8160A	HT-8160B	HT-9160A	HT-9160B	HT-9160C	HT-9160D	HT-9161
Gauge Length (mm)	20 ~ 40		50	50	100	25	50
Travel Length (mm)	20 ~ 800		25	5	25	5	25
Resolution (mm)	0.004		0.001				0.001
Application	Rubber, Plastic, PE Board, Fabric, Webbing, Textile	PE Film, Latex, PVC Tubing Industry	Suitable for measuring elongation for metal, or non-metal materials with lower deformation, suitable for working at RT ~ 50 °C				



HT-8160 Series



HT-9160 Series

Tensile Test Application Grips series: Standard Wedge Grip for selected with standard machine. Pneumatic and Hydraulic Wedge Grips are optional, with excellent and convenient features for operation.

Type	SF-014D	SF-014C	SF-004-25	SF-004CB10	SF-004C5	SF-004CB2	SF-051	SF-063	SF-006	SF-301
Capacity (kN)	250	100	250	100	50	20	20	20	10	5
Clamping Range (mm)	Round	φ13 ~ φ26	φ6 ~ φ16 φ16 ~ φ38	φ6 ~ φ13 φ13 ~ φ22	φ4 ~ φ12	φ4 ~ φ9 φ8 ~ φ15	φ4 ~ φ9	φ6 ~ φ13	φ6 ~ φ11	φ0.5 ~ φ3
	Flat	0 ~ 25 W 60 x H 48	0~15, 15~30 W 52 x H 90	0 ~ 14 W 48 x H 55	0 ~ 12 W 50 x H 40	0 ~ 12 W 25 x H 40	0 ~ 8 W 50 x H 35	0 ~ 14 W 38 x H 50	0 ~ 7 W 30	0 ~ 3 W 8
Weight (kg)	50	30	116	30	15	10	15	10	5	3



SF-014D



SF-004



SF-051



SF-063



SF-006



SF-301

Type	SF-310				SF-134	SF-082	SF-215A	SF-609B
Driving Method	Hydraulic Grips				Pneumatic Grips			
Capacity (kN)	1000	500	250	100	10	0.5 / 2	1	0.5
Clamping Range (mm)	Round	φ10 ~ φ25		φ6 ~ φ16 φ16 ~ φ38	φ4 ~ φ13	φ5 ~ φ13		φ2 以内
	Flat	0 ~ 15, 15 ~ 30 W 100	0 ~ 15, 15 ~ 30 W 76	0 ~ 15, 15 ~ 30 W 52 x H 90	0 ~ 14 W 48 x H 55	0 ~ 8 W 30	0 ~ 6 H 30	0 ~ 6 H 30



SF-310

Capacity
100 kN
250 kN
500 kN
1000 kN



SF-134



SF-082



SF-215A



SF-609B

SF-082 : Grip : 1" x 1" , 1" x 3" / 1" x 2" / 1" x 3" , 1" x 3" (Option, 1 of 3)

SF-215A : Grip : 1" x 1" , 1" x 3" / 1" x 2" (Option, 1 of 2)

Peeling, Shearing, Lunging, Plunger, Adhesion, Punctures Fixtures Series for Selections (Optional)

Type	SF-087A	SF-081	SF-005	SF-148	SF-162
Applications	Puncture Fixture for Safety Shoes	90° Peeling Fixture	Lunging Fixture	Plunger Fixture	X-Y Table



SF-087A



SF-081



SF-005



SF-148

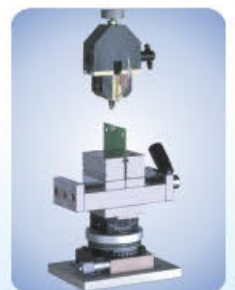

SF-162

SF Test Application Grips Series

Type	SF-046	SF-072	SF-093	SF-147A
Applications	Fixture for Bolt Nut Shape	Fixture for Ropes & Cable	Tensile Grip for Rubber & Plastic	Wedge Clamps for Finished Products
Capacity (kN)	50 / 100 / 300 / 600	20 / 50 / 100 / 200	1	1
Clamping Range (mm)	50 / 100 kN : M4 - M10 300 kN : M6 - M16 600 kN : M6 - M36	width 20, 50, 100	8 x 50	10 x 6 10 x 25



SF-046

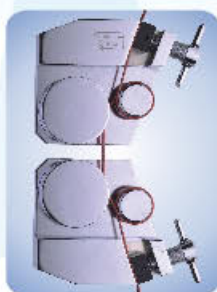

SF-158A3



SF-072



SF-093



SF-093A



SF-147A

Compression Test Fixture Series

Compression platen for metal, rubber, timbering and cement.

Type	SF-156	
Platen Size (mm)	Dia. 50 / 80 / 120 / 160 220 / 280 / 300	150 x 300, 300 x 300

Type	SF-122A	
Platen Size (mm)	ø 75 / ø 102 / ø 164 / ø 204	



SF-156



SF-122A

Type	SF-199	SF-010B
Applications	PVC	Textile
	Tensile Grip for PVC	Textile Caught Grip
Capacity (kN)	2	2



SF-199



SF-010B

Bending Test Fixture for metal, china / ceramic, tile, concrete cylinder, timber, and so on.

Type	SF-002A Series
Max. Load (kN)	10, 20, 50, 100
Loading Radius (mm)	R2, R5, R1/8 (Optional)
Supporting Radius (mm)	R2, R5, R1/8 (Optional)
Width (mm)	50 (110 Optional)
Supporting Distance (mm)	20~80 / 20~200/20~600



SF-002A

Type	SF-155 Series		
Max. Load (kN)	300	500	1000
Loading Radius (mm)	R15	R25	R25
Supporting Radius (mm)	R15	R25	R25
Width (mm)	120	120	160
Supporting Distance (mm)	30 ~ 400		



SF-155

Since 1975



Website : www.hungta.com
www.hungta.com.tw
www.hungta.com.cn
www.hungtathai.com

HUNG TA INSTRUMENT CO., LTD.

Headquarters & Factory

No. 20, Jingke Central Rd. Nantun Dist.,
Taichung City, 408, Taiwan
TEL : +886-4-23590108
FAX : +886-4-23593110
E-mail : info@hungta.com

Sales & Service in China

TEL : +86-21-57744978
FAX : +86-21-57744980
Mobile : +86-139-16418127
+86-139-17764730

Global Office

Taipei Office
TEL : +886-2-27467770
FAX : +886-2-27686430

Kaohsiung Office
TEL : +886-7-3429618-9
FAX : +886-7-3427499



Thailand Office
TEL : +66-2-3120446-8
FAX : +66-2-3120445

Malaysia Office
TEL : +60-6-7636031
FAX : -60-6-7637692

Vietnam Office
TEL : +84-283-7517821

Indonesia Office
TEL : +62-21-42884548, 42802050
FAX : +62-21-42884558